

ULTRALIFT™

High Performance Powered Hand Trucks

Ultra Lift supplies the power—so you don't have to. One person can safely and easily handle loads that usually require 2 or 3 people, even up or down stairs. Two people can handle most loads to 1500 pounds. If safety is your concern, **Ultra Lift** is the best move you'll ever make.

Operator Safety

Injuries can be virtually eliminated. **Ultra Lift** does the lifting so that operator effort required to complete a move is minimized. Heavy loads are broken back with ease. The operator stays in control by using a combination of motor power, balance, and leverage in every phase of the move.

Reduce Labor Costs

Fewer people are required for any move with **Ultra Lift**. Manpower can be scheduled more productively. Labor savings often pay for the **Ultra Lift** in one month.

Eliminate Damage

Loads are broken back, set down and moved under power with maximum leverage and operator control. Gentle handling eliminates bumps, bounces and damage to the load and premises.

Increase Profits

Increased operator safety, reduced labor cost and elimination of damage to the load and premises all contribute to significant increases in profits.

ULTRA LIFT CORPORATION
475 Stockton Avenue, Unit E
San Jose, CA 95126
800-346-3057; 408-287-9400
Fax 408-297-1199
info@ultralift.com



Up & Down Stairs



4 Wheel Dolly Move



On & Off Truck

ERGONOMIC POWERED MOVING SYSTEMS

We listen to our customers – Ultra Lift Powered Hand Trucks and accessories have been developed to meet the unique requirements of the markets we serve. The following is a sampling of users who have found Ultra Lift to be indispensable:

- **SAFE COMPANIES**
- **VENDING OPERATORS & SOFT DRINK BOTTLERS**
- **APPLIANCE DEALERS**
- **OFFICE EQUIPMENT COMPANIES**
- **MILITARY AND GOVERNMENT AGENCIES**
- **PLANT MAINTENANCE OPERATORS**
- **FACILITIES MANAGEMENT GROUPS**
- **ELEVATOR COMPANIES**
- **UTILITY COMPANIES**
- **TRUCKING & DELIVERY COMPANIES**
- **CONTRACT MOVERS**

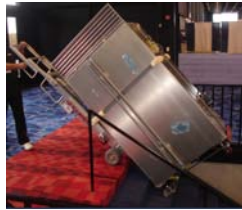

ULTRA LIFT MODEL	LOAD CAPACITY	LIFT HEIGHT	MACHINE HEIGHT	MACHINE WEIGHT
1500	1500#	41"	62-72"	120#

Machine weight includes strap bar, 4 wheel dolly and spill proof battery. Minimum over-all machine height is with extension handle retracted for moves in restricted areas. Maximum height is with handle fully extended for maximum leverage.



ULTRA LIFT[™]

The Best Move You'll Ever Make!



Pricing and Accessories

Ultra Lift Model 1500 Powered Hand Truck

\$3750.00

1500 Pound Capacity; 41" Vertical Lift

Shipped Complete with:

- Variable Position Strap Bar with Nylon Strap
- Extension Handle to Adjust Overall Machine Height
- Swing Out 4 Wheel Dolly Attachment
- Leverage Bar for Easy Break Back of Loads
- Safety Override Clutch for Drive System
- Fully Automatic Anti-Reverse Brake
- Spill Proof, Sealed Battery – 12 Volt, 34 Amp Hour
- Battery Charger with Pre-Wired Charging Plug
- One Year Warranty
-

CALL FOR INFORMATION ON OTHER MODELS. MANY SPECIALTY APPLICATION MODELS, CUSTOM UNITS, AND ADDITIONAL ACCESSORIES ARE AVAILABLE.

Model SEH Strong Arm Extension Handle

- Handle, Top Switch, Duplicate Control Circuit

The Model SEH provides an extra foot of leverage, reducing the effort on stairs by half. Use the extra height to position yourself securely above unusually tall or heavy loads. A top mounted auxiliary switch provides ease of operation and control.

\$300.00

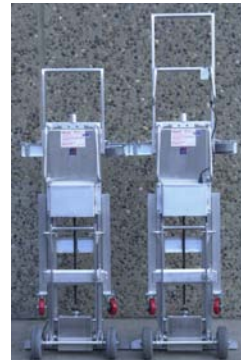

Model QMW Quad Main Wheel Package

- Two Additional Main Wheels and Longer Axle

The standard Ultra Lift Model 1500 appears on the left. The Ultra Lift on the right is equipped with the Model QMW Quad Main Wheel package. Quad wheels improve stability on stairs and improve weight distribution on moves over sensitive floors.

\$150.00

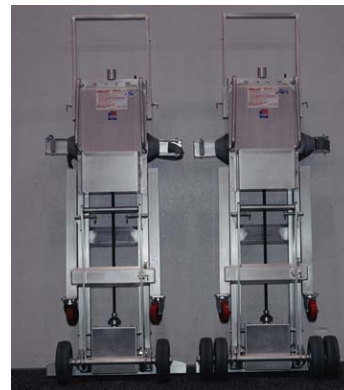

ACCESSORIES (continued):

Model VMA Vertical Move Assembly

- Deck, Caster Plate, Strap and Strap Bar Post

The VMA solves many “tight” location moving problems by enabling installers to move large, heavy loads in an upright position. The floor space required to turn corners and negotiate landings is minimized. The load rolls easily on Ultra Lift’s main wheels and the VMA Caster Plate.

\$325.00



Model VGH Vacuum Grip Handle

- Rigid Metal Construction; 8” Diameter Pad

The Model VGH can be attached quickly and easily to any flat, smooth, non-porous surface to provide a solid hand grip where you need it. It keeps hands clear of load edges on moves through doorways or narrow halls and simplifies turning, positioning and pulling loads when used with the VMA.

\$125.00

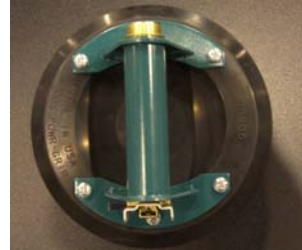

Model PLE Portable Landing Extender

- Adds 33” to Small Landings

For use on landings where there is not enough space to set the load down safely and making a turn would be almost impossible. The Model PLE is particularly effective when used in combination with the Model VMA.

\$475.00



Set Off Spacers

The Set Offs are spacer bars that attach directly over the Lift Plate and Strap Bar. They position the load being moved an additional 2.5” away from the Lift Frame to allow front loading of safes without damage to handles or locks.

\$200.00

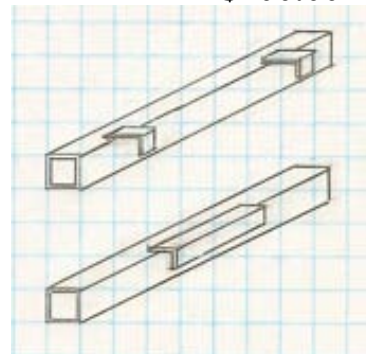

ACCESSORIES (continued):

Model LP6WD Low Profile 6 Wheel Dolly

- 32" Wide by 24" Deep Dolly Deck;
4" Overall Height

The LP6WD provides maximum maneuverability on small landings and is most effective when used in conjunction with the Model PLE Portable Landing Extender. Ideal for "zero clearance" moves.

\$350.00



Model RTA Rough Terrain Assembly

- 16" Diameter Pneumatic Wheels,
Removable Tripod Frame and Axles

The Model RTA adds stability and greatly reduces the operator effort required to move loads over rough surfaces such as broken pavement; unpaved areas such as dirt, rock and gravel; and soft surfaces such as lawns, sand and snow.

\$250.00



Model HMA Horizontal Move Assembly

- Caster Plate; Lock Bar; Remote Switch

Ultra Lift enables operators to lay tall loads down horizontally under power for balanced moves through low doorways. The HMA attaches directly to the Ultra Lift before lay down and lets the operator shorten the horizontal load for improved maneuverability. The HMA is used for short runs on flat surfaces and should not be used on stairs or inclines.

\$250.00

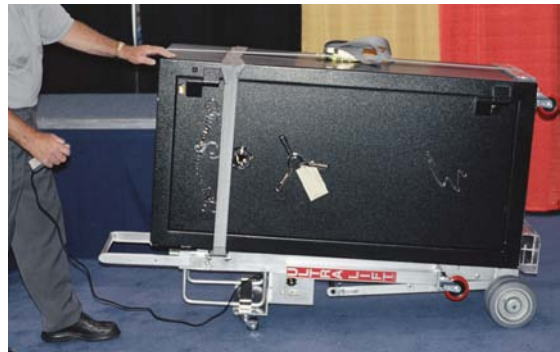

Door Guards

- 13" Wide by 28" Long; Five Door Guards per Package

Door Guards snap around doorjamb to provide added protection for both the location and the load. Five Door Guards effectively protect each side and the top of most doorways.

\$115.00



ACCESSORIES (continued):

Model CBA Concave Barrel Attachment

The Model CBA Concave Barrel Attachment attaches directly to the strap bar with wing nuts and provides additional side to side stability for cylindrical loads such as drums and water heaters.

\$95.00

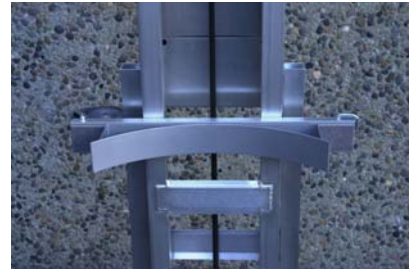

Model FHA File Handling Attachment

- Extension Arm, Strap Bar Post & Over Plate

The Model FHA is used to move one file cabinet into or out of a side-by-side bank of files very simply & safely. The 14" wide lift plate extender is placed under the front of the file. The telescoping extension arm, hinged to a vertical post on the strap bar, swings down and behind the file cabinet so that it can be moved out without having to strap around the file.

\$225.00



Model CGM Case Goods Mover

- Over Plate, Strap Bar Post & Ratchet Strap

The Model CGM Case Goods Mover fits over Ultra Lift's standard lift plate to provide a 19" x 24" deck for stacking up to 20 cases of product, paper, or supplies.

\$175.00



Model SCL Strap & Channel Loading System

- Low Profile Lock Channel
- Adjustable Loading Strap
- Safety Stop

The Strap & Channel Loading System enables one person with an Ultra Lift to very safely and easily move heavy loads on and off trucks.

\$125.00

